



Heavy Duty Storage Shelving 2700H x 1500W x 600D

Product Images



Description

Heavy Duty Storage Shelving 2700H x 1500W x 600D

Long Span Shelving is a complete storage system ideal for garage, warehouse, retail and industrial storage applications. These typically include automotive and other spare parts, hardware, bulk retail and general purpose carton and archive storage. Long Span can accommodate a wide range of storage requirements, including your home garage.

Strong = Safe

Each shelf is strong enough to hold 200kg (meaning it won't buckle in case you climb up the shelf), with an overall 800kg capacity. Furthermore, thick shelf panels with back support completely eliminate all weak points. Moreover, bolts attaching the horizontal beams to the upright posts keep it all together when moving around.

If you require shelving that is hard-wearing, carries large weight loads and is aesthetically pleasing, then this is perfect for you.

MEASURING SAMPLE

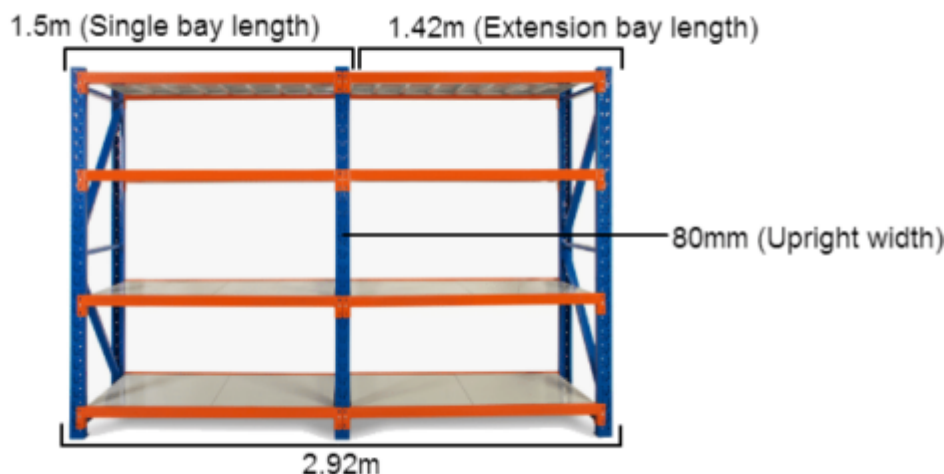
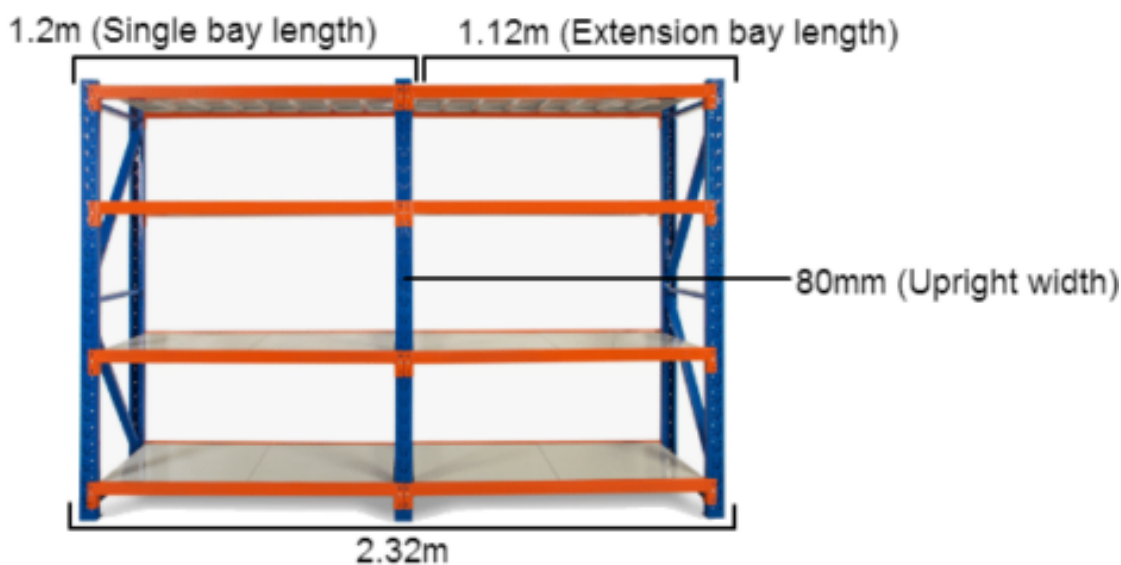

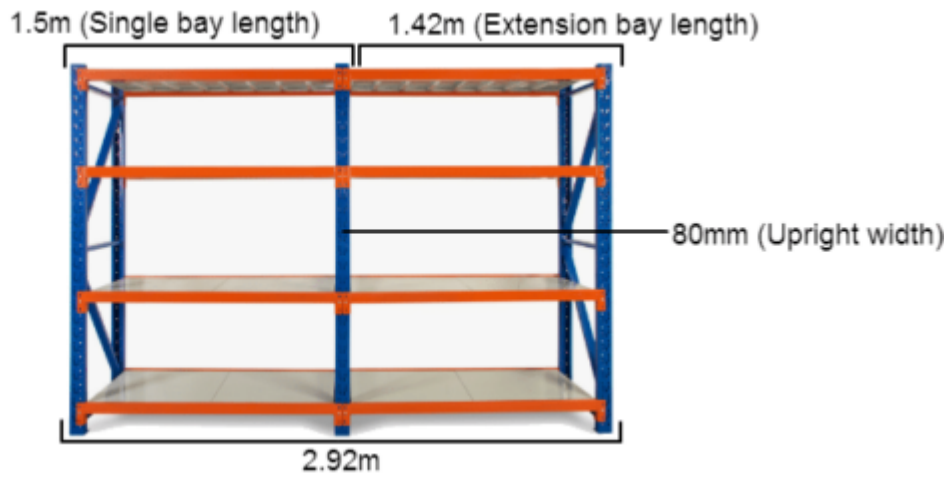

*Based on a 3m shelving unit. The same principle can be applied to 1.2m, 1.5m and 2m shelving units to work out precise length.

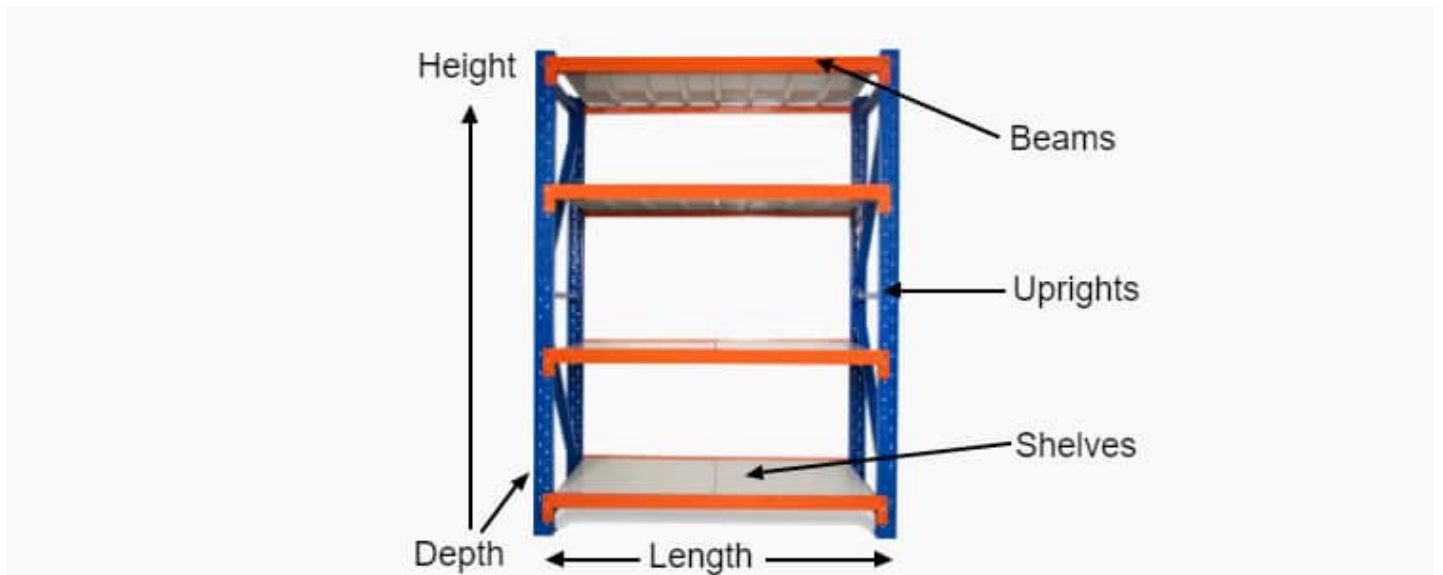

FEATURES

- 1 Bay
- Metal shelves included
- Extendable shelving system
- Adjustable shelf height
- Click-in system with nuts and bolt for extra security
- Free standing or fixed to the ground
- Made of heavy duty metal and powder coated
- Available ADD-ON KITS (Extensions) 0.9m, 1.2m, 1.5m and 2.0m

WARRANTY

1-year limited warranty

